



Installation Instructions

HighRock 4x4™ Element™



Lower Door Frame



Vehicle Application

•Jeep CJ-7 / CJ-8 Scrambler
1976-1986
Part Number: 51807 / 51823

•Jeep Wrangler
1987-1995
Part Number: 51807 / 51823

www.Bestop.com - We're here to help! Visit our web site and click on "[Ask a Question](#)". Click here for more [Jeep Accessories by Bestop](#).

INSTALLATION TIME	SKILL LEVEL
 1/2 Hour	 1 - Easy

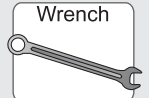
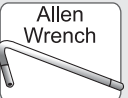
TOOLS			
 Safety Glasses	 Phillips Screwdriver	 Wrench 7/16" and 3/8"	 Allen Wrench





Installation Tips

Before you begin installing this assembly, read all instructions thoroughly.

For a smooth fit:

For ease in installation, the product should be installed at temperatures above 72° F. Below this temperature, the fabric may contract an inch or more, making it difficult to fit to the vehicle. It is normal for fabric to contract and wrinkle when stored in the shipping carton. Within a few days after the installation, the fabric will relax and the wrinkles will disappear.

 **CAUTION** Safety glasses should be worn at all times while installing this product.

 **WARNING** This product is designed primarily to enhance the appearance of the vehicle and to shield the occupants from ordinary weather conditions. Do not rely in any way on the components of this product to contain occupants within the vehicle, or to protect against injury or death in the event of an accident. This product will not protect the occupants from falling objects. Never operate the vehicle in excess of manufacturer's specifications.

WEAR SEAT BELTS AT ALL TIMES

Read and follow, precisely, all installation instructions provided when installing product. Failure to do so may result in a poor fit and could place occupants of the vehicle in a potentially dangerous situation.

HighRock 4x4™ Element™ Lower Door Frame – Installation Instructions

Parts List

Right Door Frame, Part Number 422.12 (GLOSS FINISH)
 Part Number 499.48 (MATTE FINISH)
 Qty - 1
 Left Door Frame, Part Number 422.00 (GLOSS FINISH)
 Part Number 499.47 (MATTE FINISH)
 Qty - 1

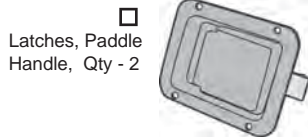

Latches, Paddle Handle, Qty - 2



Door Restraint Straps, Qty - 2, Part Number 393.23

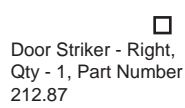

Door Striker - Right, Qty - 1, Part Number 212.87

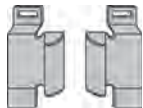

Door Striker - Left, Qty - 1, Part Number 212.88



Dome Light Switch Bracket, Part Number 454.52, Qty - 2

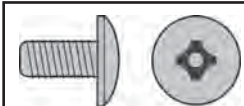

#10-32 Truss Head Machine Screw - Black, Qty - 12, Part Number 316.82

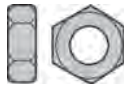

#10-32 Locknut - Black, Qty - 12, Part Number 316.94

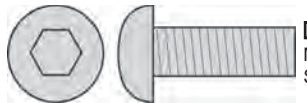

M6 x 10 Button Head Screw, Qty - 4

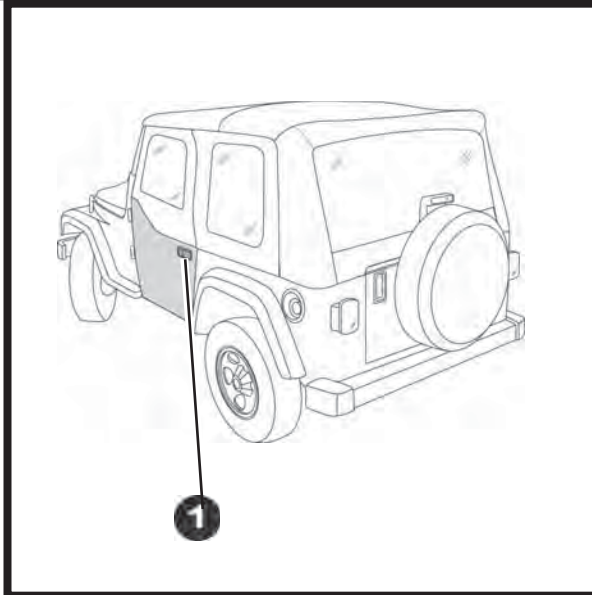

! WARNING The Element Door System is equipped for protection against the elements. The door will not contain occupants during an accident. Wear Seatbelts at all times

IMPORTANT: You should check alignment of the Paddle Handle to the steel latch pin before tightening the screws. If out of alignment, align and retighten the screws securely. Repeat for both lower doors. If more adjustment is needed, adjust the vehicle's door striker.

1 Install Paddle Handle

Insert the Paddle Handle into the mounting plate so that the latch mechanism is inside of the vehicle and the Rotary Latch Mechanism is toward the rear of the door. Align the four holes in the Paddle Handle Assembly with the four holes in the mounting plate. Insert four #10-32 Truss Head Machine Screws from the outside and secure them with #10-32 Locknuts. Do not tighten the screws until all four are in place.

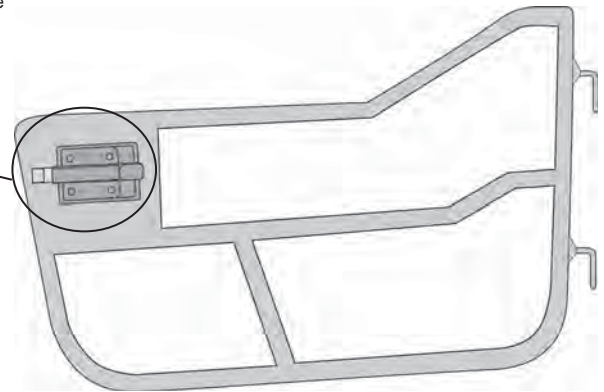
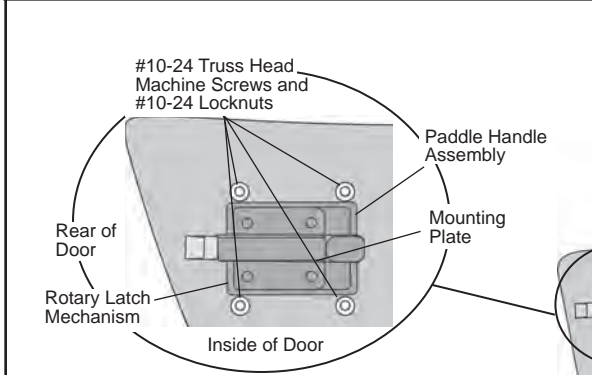

HighRock 4x4™ Element™ Lower Door Frame – Installation Instructions

2 Install Door Strikers

Orient the Door Strikers with the raised edge toward the top and with the flat face toward the inside of the vehicle. Install the Door Striker on the Vertical Retainer Mount with two #10-32 Truss Head Machine Screws and two #10-32 Nuts. Once the door is installed, the Door Striker may be adjusted in or out until you are satisfied with the way the Door shuts and opens. Repeat on both sides of the vehicle.

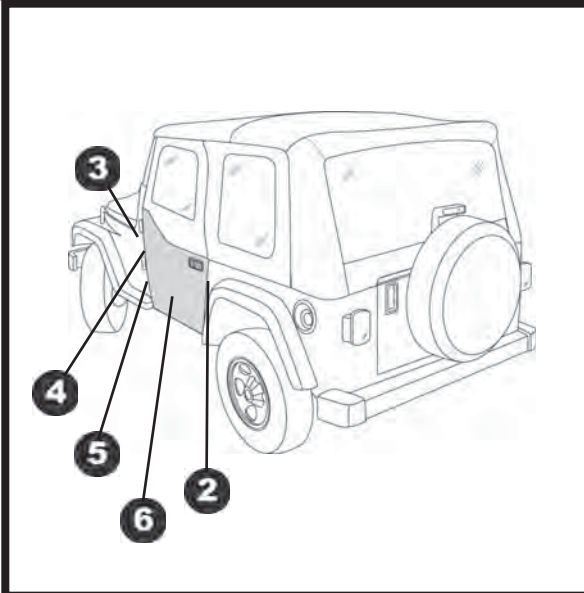
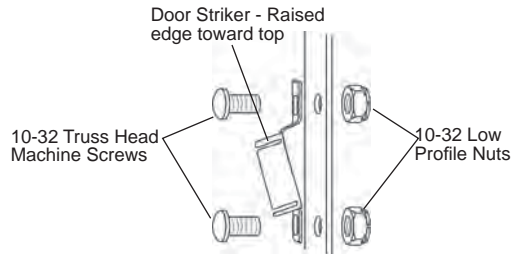

5 Install Restraint Strap

Locate a Door Restraint Strap in the small parts kit. Slip the loop in one over the hook on the door frame. Slip the loop in the other end onto the hook on the vehicle body.

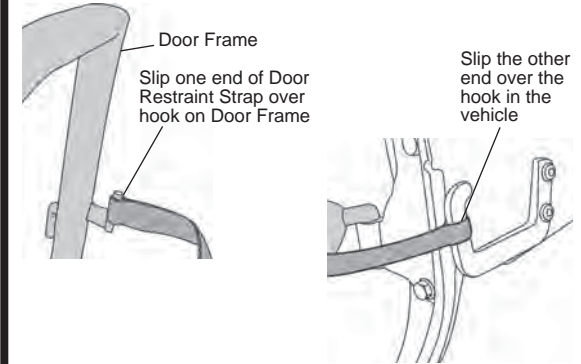

3 Install Door

Hold the door straight out from the vehicle with the hinge pins over the body hinges. Lower the pins into the hinges. Make sure that the pins are fully inserted into the body hinges. Adjust the body hinges and latch pin if necessary.

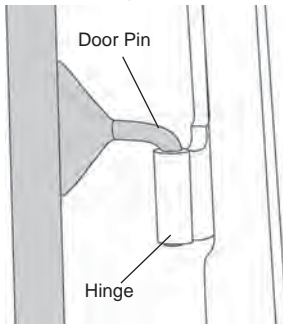

4 Install Dome Light Switch Bracket

Locate the Dome Light Switch on the vehicle. Mount the Dome Light Switch Bracket to the Door in that location. Adjust the bracket location so that the dome light turns off when the Door is closed. Repeat on both sides of the vehicle.

NOTE The Dome Light Switch Bracket is not used on CJ Models.

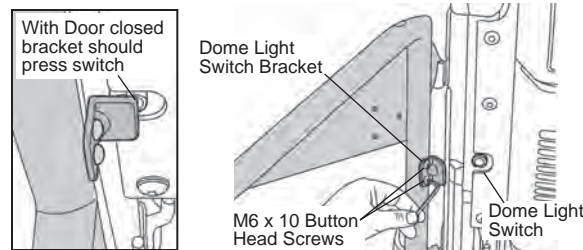

HighRock 4x4™ Element™ Lower Door Frame – Installation Instructions

LIMITED WARRANTY

We warrant our product to be free from defects in material and workmanship, for the terms specified below, provided there has been normal use and proper maintenance. This warranty applies to the original purchaser only. All remedies under this warranty are limited to the repair or replacement of any item or items found by the factory to be defective within the time period specified. If you have a warranty claim, first you must call our factory at the number below for instructions. You must retain proof of purchase and submit a copy with any items returned for warranty work. Upon completion of warranty work, if any, we will return the repaired or replaced item or items to you freight prepaid. Damage to our products caused by accidents, fire, vandalism, negligence, misinstallation, misuse, Acts of God, or by defective parts not manufactured by us, is not covered under this warranty.

THE WARRANTY TIME PERIOD IS AS FOLLOWS FOR REPLACE-A-TOP™, SAILCLOTH REPLACE-A-TOP™, SUPERTOP®, SUPERTOP® REPLACEMENT SKINS, SUNRIDER®, AND TIGERTOP®: TWO YEARS FROM DATE OF PURCHASE.

THE WARRANTY TIME PERIOD IS AS FOLLOWS FOR ALL OTHER “SOFT GOODS” MANUFACTURED BY OUR COMPANY (USING PRIMARILY VINYL, PLASTICS, AND/OR FOAM): ONE YEAR FROM DATE OF PURCHASE.

THE WARRANTY TIME PERIOD IS AS FOLLOWS FOR ALL OTHER “HARD GOODS” MANUFACTURED BY OUR COMPANY (USING PRIMARILY METALS, PLASTICS, AND/OR FIBERGLASS): ONE YEAR FROM DATE OF PURCHASE.

ANY IMPLIED WARRANTIES OF MERCHANTABILITY AND/OR FITNESS FOR A PARTICULAR PURPOSE CREATED HEREBY ARE LIMITED IN DURATION TO THE SAME DURATION AND SCOPE AS THE EXPRESS WRITTEN WARRANTY. OUR COMPANY SHALL NOT BE LIABLE FOR ANY INCIDENTAL OR CONSEQUENTIAL DAMAGE.

Some states do not allow limitations on how long an implied warranty lasts, or the exclusion or limitation of incidental or consequential damages, so the above limitations or exclusions may not apply to you. This warranty gives you specific legal rights, and you may also have other rights which vary from state to state.



For further information or request for warranty work, please contact:
Bestop Inc., Customer Service
Toll-Free: (800) 845-3567
Main: (303) 465-1755
E-mail: csbestop@Bestop.com
Website: www.Bestop.com

*All or a portion of this product may be made in China or South Africa.